

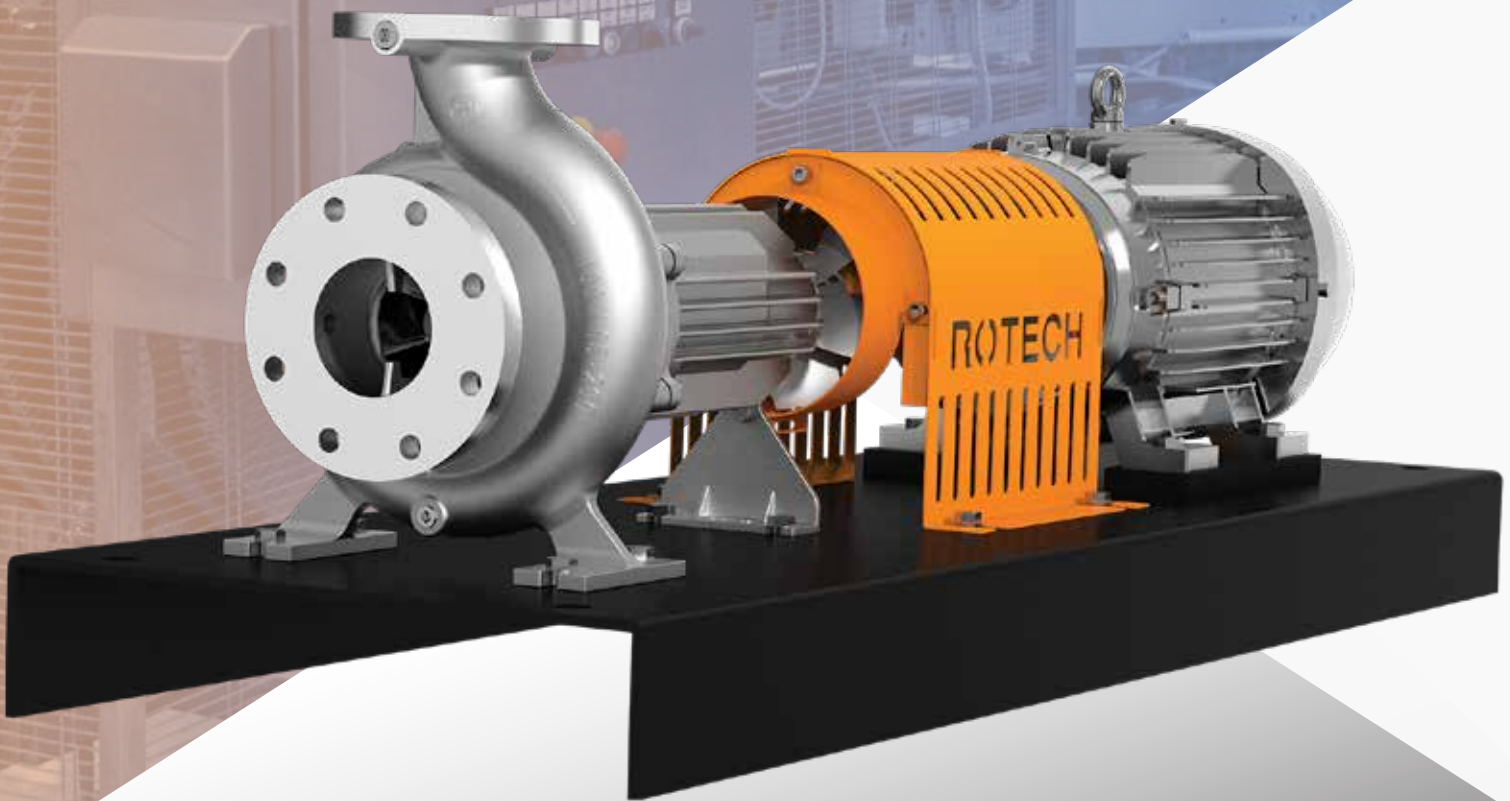

Quality | Commitment | Adaptability

High on Pump
Efficiency
Great on
Reliability



www.rotechpumps.com

RoTherm (ISO 2858/5199)
Closed Impeller Hot Oil / Water Pump

Pump Design Features

- Cost Effective solution for pumping a Thermic fluid like hot water and hot oil.
- Working Temperature range: -30° to +350°C for Thermal Oil
Up to +180°C for Hot Water

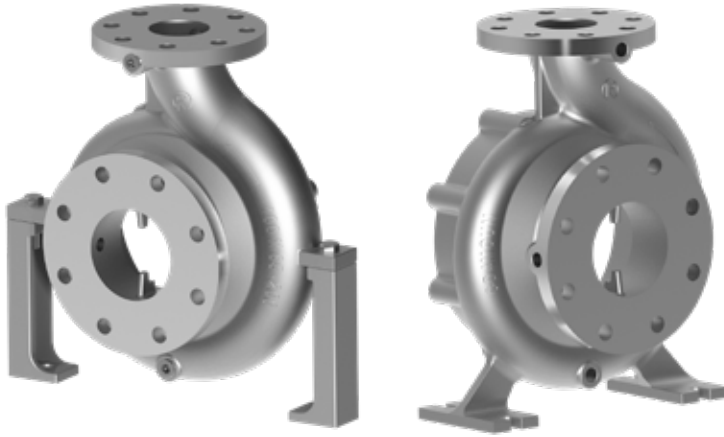

Centerline Mounted Casing (optional)

- Both casings are available with foot mounted and Centerline mounted design.
- Centerline design is used to compensate thermal expansion of casing's dimension.

Flange Options

- Standard : PN 16 Raise Flange (EN 1092-1)
- Optional : PN 25 Raise Flange (EN 1092-1), ASME B 16.5 – Class 150 (Only with thru drill Holes)

Power End

- Finned designed power end works as a radiator which is used to increase surface area of bearing frame, which helps in lowering bearing temperature.
- Fan is running with pump shaft and it is continuous throwing fresh cool air from atmosphere to pump's bearing frame



Shaft Kit

- Bigger outer diameter makes it a rigid sub-assembly
- Single component seal is already mounted on the shaft, which eliminate external costly sealing options
- Carrier assembly provides a double sealing

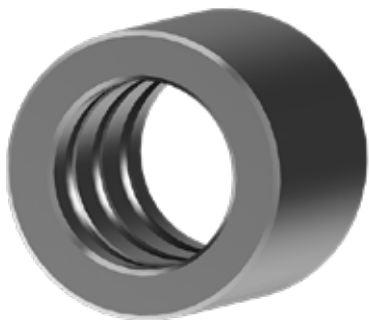

Throttling Bush

- Directly opposed the pressurized hot pumping liquid
- Helps in reducing temperature of bearing and seal

Carbon Bush

- It directly isolates pumping liquid and coolant



Additional Cooling Feature

- Power frame is specially design for high temperature operation by circulating cooling liquid from two ports shown in figure. It has additional port which will indicate mechanical seal failure.

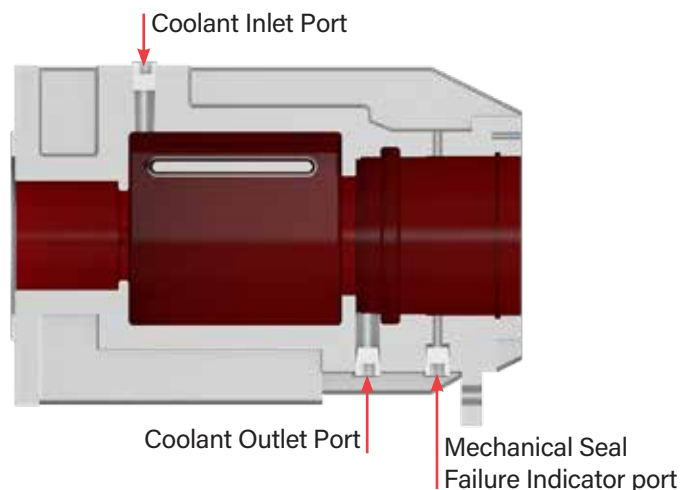

HYDRAULIC PERFORMANCE COVERAGE

With 4 Pole Motor

Capacity up to 6384 GPM (1450 m³/h) | Head up to 450 feet (137 m) | Temperature to 752° F (400° C)
Pressure to 362 PSIG (2500 kPa)

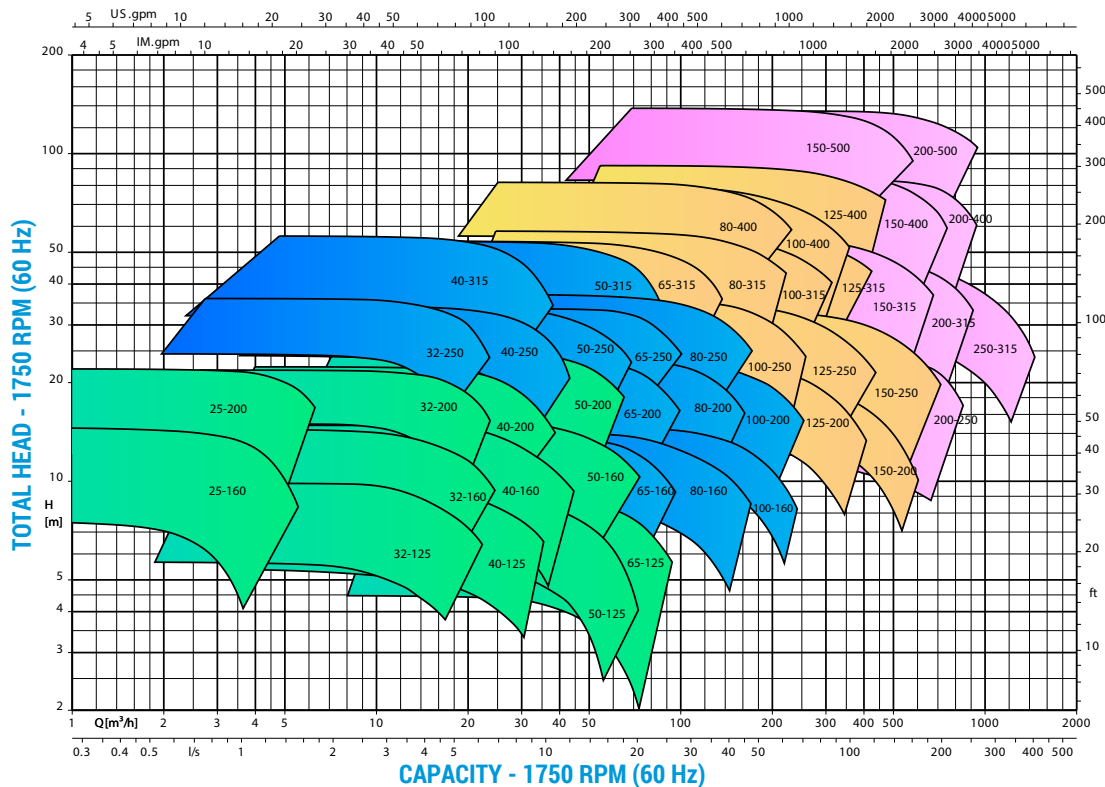

With 2 Pole Motor

Capacity up to 3300 GPM (750 m³/h) | Head up to 754 feet (230 m) | Temperature to 752° F (400° C)
Pressure to 362 PSIG (2500 kPa)

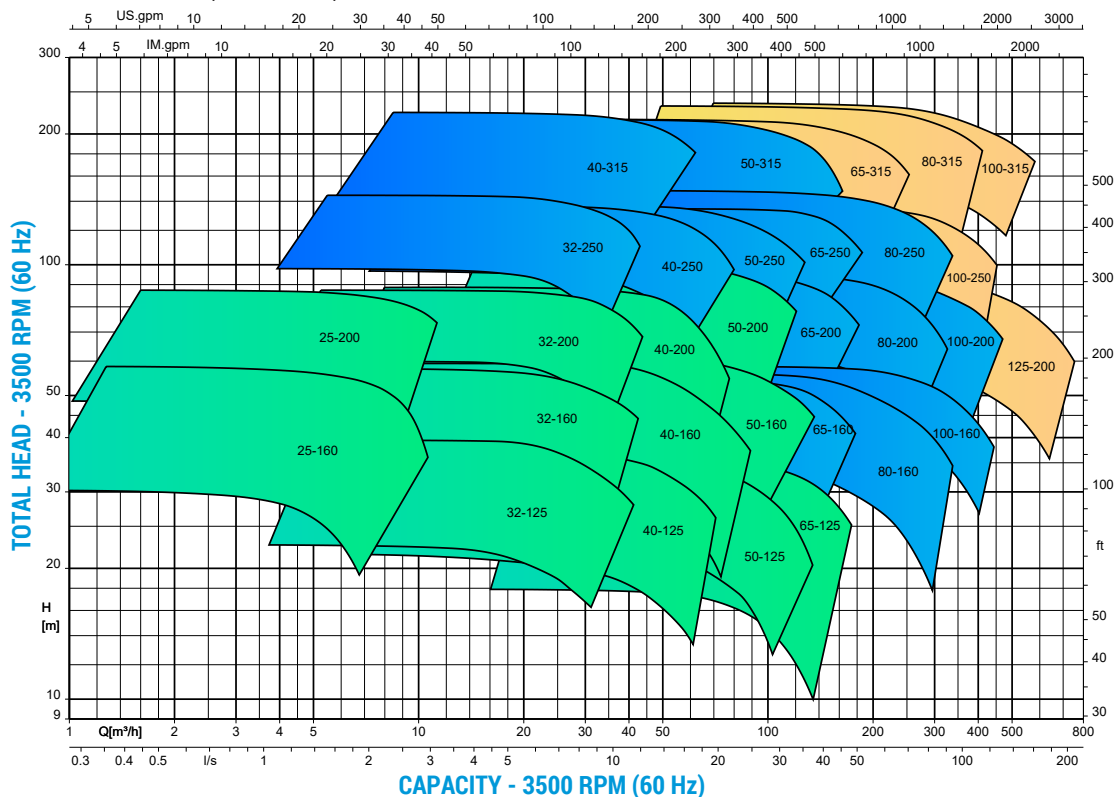

ROTECH ISO 2858/5199 PROCESS PUMP

Design Features & Benefits

Casing

- Additional featured with suction vortex breaker vanes
- Self-venting, centerline mounted discharge flange
- Precision serrated flange face finish for optimum gasket retention and sealing.
- Flange Options: -PN 16 RF (Standard) and PN 25 RF (Optional) , ANSI B16.5 150# (Only with thru drill Holes)
- Back Pull out design for easy maintenance
- Center line mounted foot are also available for high temperature fluid.

Impeller

- Closed Impeller design for increasing efficiency
- Moderate solid handling capacity with ease in pumping fibrous material.
- Back pump out curved vanes reduces pressure on shaft seal and throw out solid particles
- Balanced with grad G 6.3 of ISO 1940

Wear Ring

- Protects Impeller's wear
- Sustain and balance pump's radial load
- Optimized leakage gap causes higher pump efficiency

Gasket

- PTFE, Glass filled Teflon for all pumps.
- Positive liquid sealing

Throatling Bush

- Directly oppose the pressurized hot pumping liquid.
- Helps in reducing temperature of Bearings and Seals.

Delivery

Pumps/parts are strategically inventoried at various locations in North America, Asia for rush delivery in various material options.

Casing Drain

- Casing drain port as standard
- Drain piping as optional

Foot Mounted Casing

- Maximum casing stability and support for back pull-out maintenance feature
- Reduced vibration

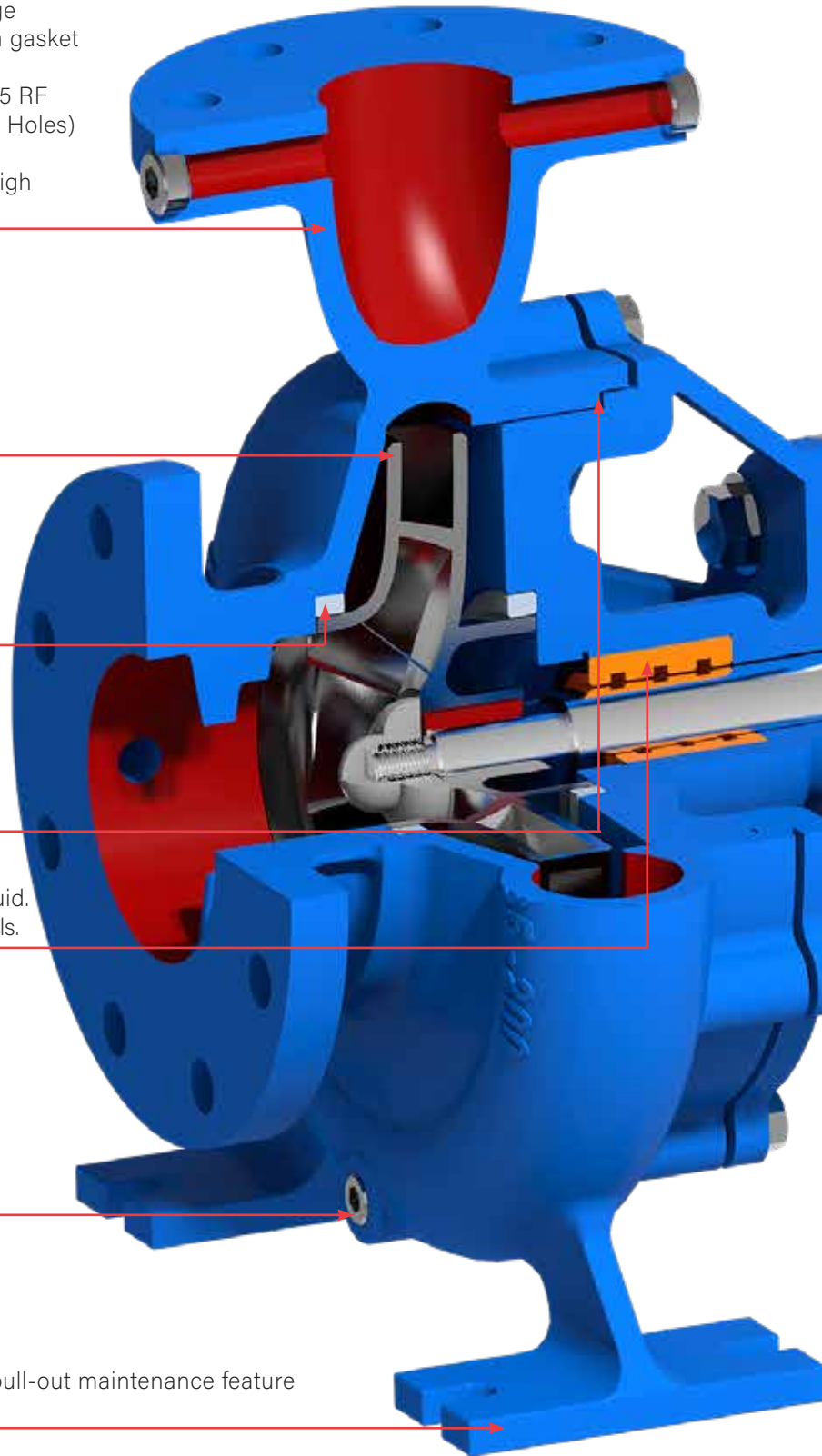

Bearing Frame

- Specially designed with ribs for enhancement in radiation to keep lower temperature of bearing near about 140°C
- Optimize oil sump capacity for increased cooling
- Pressurise all lubrication system can be accommodate
- Lubrication Option: Oil and Grace both can be used
- Contoured internal slope for positive collection of metal contaminants by magnetic drain plug
- Internal surface cleaned, rust preventative applied, and enamel coated assuring internal casting cleanliness

Pump Selector Program

Access to end users and specifiers to select your pump application online at www.rotechpumps.com or Contact us for more help

Matting Ring Carrier

- Component Mechanical Seal with SS carrier and Viton's sealing which will be sustain at high temperature.

Bearing

- Radial Bearing (Grease lubricated) which helps in sustaining bearing at high temperature.

Fan

- Worked as Radiator
- Keep cools Bearing

Component Mechanical Seal

Plug for Cooling Liquid Outlet*

Bearing Frame Leg

- Provides Additional Stability to pumps and helps in Reduction in vibration which extends Bearing life.

Drain Plug*

- It indicates failure of mechanical seal

Shaft and Sleeve











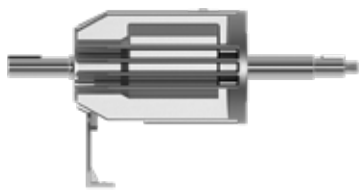

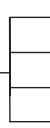
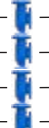



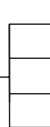

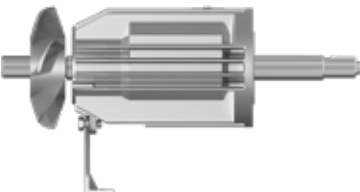

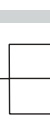
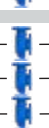



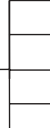

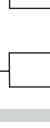
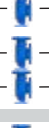
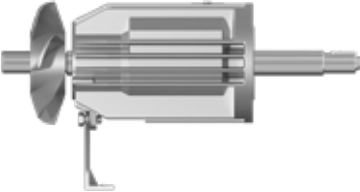



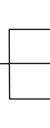



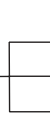
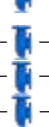
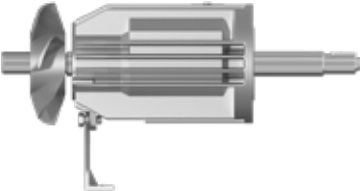

- Standard: SS316 Shaft sleeve with 4140 AISI Shaft
- Optional: Solid Shaft (MOC-AISI 4140, SS316, A2205,A2507, Alloy 20, Monel, Nickel, Hastelloy B,C & Titanium)
- Sleeve Shaft (MOC- AISI 4140 and SS316)
- Rigid heavy duty design for minimum shaft deflection at seal area and increased reliability
- Low deflection at seal faces for longer seal and bearing life

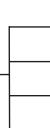
Carbon Bush

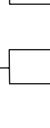
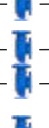
- It directly isolates pumping liquid and coolant.

Note: (*) Not Illustrated

INTERCHANGEABILITY CHART

Power Frame	Adapter	Impeller	Casing	Size
 <p>Group 1</p>	 125			50x32-125
				65x40-125
				80(65)x50-125
	 160			100(80)x65-125
				40x25-160
				50x32-160
	 200			65x40-160
				80(65)x50-160
				40x25-200
 <p>Group 2</p>	 160			50x32-200
				65x40-200
				80(65)x50-200
	 200			100(80)x65-160
				125(100)x80-160
				125x100-160
	 250			100(80)x65-200
				125(100)x80-200
				125x100-200
 315			50x32-250	
			65x40-250	
			80(65)x50-250	
 <p>Group 3</p>	 200			100(80)x65-250
				125(100)x80-250
				125x100-250
	 250			150x125-200
				200x150-200
				125x100-250
	 315			150x125-250
				200x150-250
				100(80)x65-315
 400			125(100)x80-315	
			125x100-315	
			150x125-315	
 <p>Group 4</p>	 315			125(100)x80-400
				125x100-400
				150x125-400
	 400			200x200-250
				200x150-315
				250x200-315
 500			300x250-315	
			200x150-400	
			250x200-400	
 500			200x150-500	
			250x200-500	
			250x200-500	

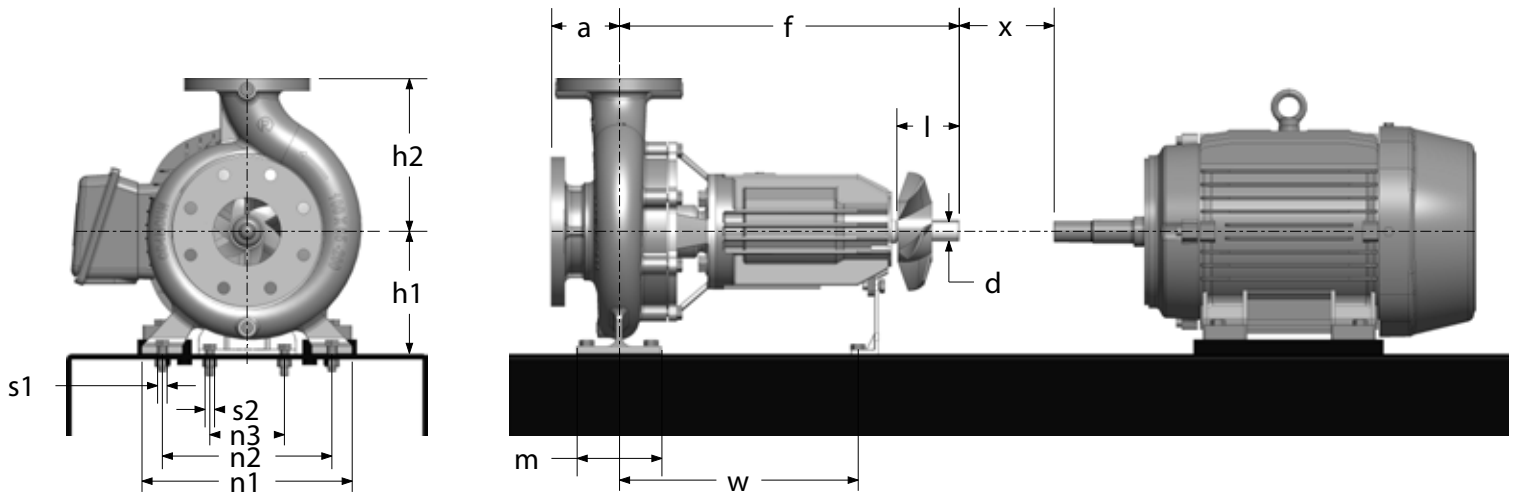

PUMP DIMENSIONS AND WEIGHTS

Size	Bearing frame	Suction Flange	Discharge Flange	Pump				Support				Clearance holes for bolts		Shaft End			
				EN 1092-1				a	f	h1	h2	m	n1	n2	n3	w	s1
40x25-160	G1	40	25	80	385	132	160	100	240	190	110	285	14	14	24	50	100
40x25-200	G1	40	25	80	385	160	180	100	240	190	110	285	14	14	24	50	100
50x32-125	G1	50	32	80	385	112	140	100	190	140	110	285	14	14	24	50	100
50x32-160	G1	50	32	80	385	132	160	100	240	190	110	285	14	14	24	50	100
50x32-200	G1	50	32	80	385	160	180	100	240	190	110	285	14	14	24	50	100
50x32-250	G2	50	32	100	500	180	225	125	320	250	110	370	14	14	32	80	100
65x40-125	G1	65	40	80	385	112	140	100	210	160	110	285	14	14	24	50	100
65x40-160	G1	65	40	80	385	132	160	100	240	190	110	285	14	14	24	50	100
65x40-200	G1	65	40	100	385	160	180	100	265	212	110	285	14	14	24	50	100
65x40-250	G2	65	40	100	500	180	225	125	320	250	110	370	14	14	32	80	100
65x40-315	G2	65	40	125	500	200	250	125	345	280	110	370	14	14	32	80	100
80(65)*x50-125	G1	80	50	100	385	132	160	100	240	190	110	285	14	14	24	50	100
80(65)*x50-160	G1	80	50	100	385	160	180	100	265	212	110	285	14	14	24	50	100
80(65)*x50-200	G1	80	50	100	385	160	200	100	265	212	110	285	14	14	24	50	100
80(65)*x50-250	G2	80	50	125	500	180	225	125	320	250	110	370	14	14	32	80	100
80(65)*x50-315	G2	80	50	125	500	225	280	125	345	280	110	370	14	14	32	80	100
100(80)*x65-125	G1	100	65	100	385	160	180	125	280	212	110	285	14	14	24	50	100
100(80)*x65-160	G2	100	65	100	500	160	200	125	280	212	110	370	14	14	32	80	100
100(80)*x65-200	G2	100	65	100	500	180	225	125	320	250	110	370	14	14	32	80	140
100(80)*x65-250	G2	100	65	125	500	200	250	160	360	280	110	370	18	14	32	80	140
100(80)*x65-315	G3	100	65	125	530	225	280	160	400	315	110	370	18	14	42	110	140
125(100)*x80-160	G2	125	80	125	500	180	225	125	320	250	110	370	14	14	32	80	140
125(100)*x80-200	G2	125	80	125	500	180	250	125	345	280	110	370	14	14	32	80	140
125(100)*x80-250	G2	125	80	125	500	225	280	160	400	315	110	370	18	14	32	80	140
125(100)*x80-315	G3	125	80	125	530	250	315	160	400	280	110	370	19	14	32	80	140
125(100)*x80-400	G3	125	80	125	530	280	355	160	435	280	110	370	18	14	32	80	140
125x100-160	G2	125	100	125	500	200	280	160	360	315	110	370	18	14	42	110	140
125x100-200	G2	125	100	125	500	200	280	160	360	355	110	370	18	14	42	110	140
125x100-250	G3	125	100	140	530	225	280	160	400	315	110	370	18	14	42	110	140
125x100-315	G3	125	100	140	530	250	315	160	400	315	110	370	18	14	42	110	140
125x100-400	G3	125	100	140	530	280	355	200	500	400	110	370	23	14	42	110	140
150x125-200	G3	150	125	140	530	250	315	160	400	315	110	370	19	14	42	110	140
150x125-250	G3	150	125	140	530	250	355	160	400	315	110	370	18	14	42	110	140
150x125-315	G3	150	125	140	530	280	355	200	500	400	110	370	23	14	42	110	140
150x125-400	G3	150	125	140	530	315	400	200	500	400	110	370	23	14	42	110	140
200x150-200	G3	200	150	180	530	280	400	200	550	450	110	370	24	14	42	110	180
200x150-250	G3	200	150	160	530	280	375	200	500	400	110	370	23	14	42	110	180
200x150-315	G4	200	150	160	670	315	400	200	550	450	140	500	23	18	48	110	180
200x150-400	G4	200	150	160	670	315	450	200	550	450	140	500	23	18	48	110	180
200x150-500	G4	200	150	180	670	375	500	200	550	450	140	500	23	18	48	110	180
200x200-250	G4	200	200	180	670	355	425	200	550	450	140	500	23	18	48	110	180
250x200-315	G4	250	200	200	670	355	450	200	550	450	140	500	23	18	48	110	180
250x200-400	G4	250	200	180	670	355	500	200	550	450	140	500	23	18	48	110	180
250x200-500	G4	250	200	200	670	425	560	200	660	560	140	500	23	18	48	110	180
300x250-315	G4	300	250	250	670	400	560	260	690	560	140	500	28	18	48	110	180

Note: (*)Suction Flange Options Available, Dimensions are approximate and not to be used for construction unless Certified by the Manufacturer.



 Corporate Office
1180 Britannia Road East,
Mississauga, ON L4W 1C8, Canada

 (905) 461-9617  Toll Free 1-866-217 7867

 rotechpumps.com  sales@rotechpumps.com

